

WINTEX 1000s, 2000, 2500, 3000, 3000s

Instruction manual

The future is in the soil -
and in professional soil samples



Content

1. **SAFETY**

 2. **MOUNTING GUIDELINES**
 - A. Mounting on a regular frame
 - B. Mounting on a reversed frame
 - C. Mounting on a pickup frame
 - D. Mounting on a tractor

 3. **USING THE WINTEX**
 - A. Description of the control system
 - B. Connection and start up
 - C. Set up menu
 - D. Settings: depth
 - E. Settings: sticks per sample
 - F. Settings: layers per sample, split mode, soil box
 - G. Soil sampling
 - H. Double rotation
 - I. Foot pressure
 - J. Test menu
 - K. Sensor adjustment

 4. **MAINTENANCE**
 - A. Replacement of o-ring, scraper, and probe
 - B. Adjustment of chain for rotation
 - C. Adjustment of chain for probe up or down
 - D. Hydraulics
 - E. Manual activation of the hydraulic valves
 - F. Adjustment of the hydraulics
 - G. Dismounting the accumulator
 - H. Control of the accumulator
 - I. Changing oil and oil filter
 - J. Maintenance schedules
 - K. Replacement of sensors

 5. **PROBLEM SOLVING**
 - A. Fault location soil sampler
 - B. Fault location hammer
-

Safety

<u>Manufactured by:</u>	Wintex Agro Vilhelmsborgvej 8C 7700 Thisted Denmark
<u>Type designation:</u>	WINTEX 1000s WINTEX 2000 WINTEX 2500 WINTEX 3000 WINTEX 3000s
<u>Voltage:</u>	12 volt DC
<u>Year of production:</u>	2025
	

1. SAFETY



- ⇒ Please maintain a sufficient distance and stay clear of the working space **before** starting the soil sampler.
- ⇒ When inspceting the soil sampler, you must always activate the emergency stop, and the vehicle must be turned off.
- ⇒ **Every time** you start the soil sampler, you must **test the emergency stop**. Do not use the soil sampler if the emergency stop does not turn it off.
- ⇒ The soil sampler has moving, sliding and rotating parts. Keep your limbs away from the soil sampler unless it is turned off, and stay away from the foot / the base of the soil sampler.

Safety

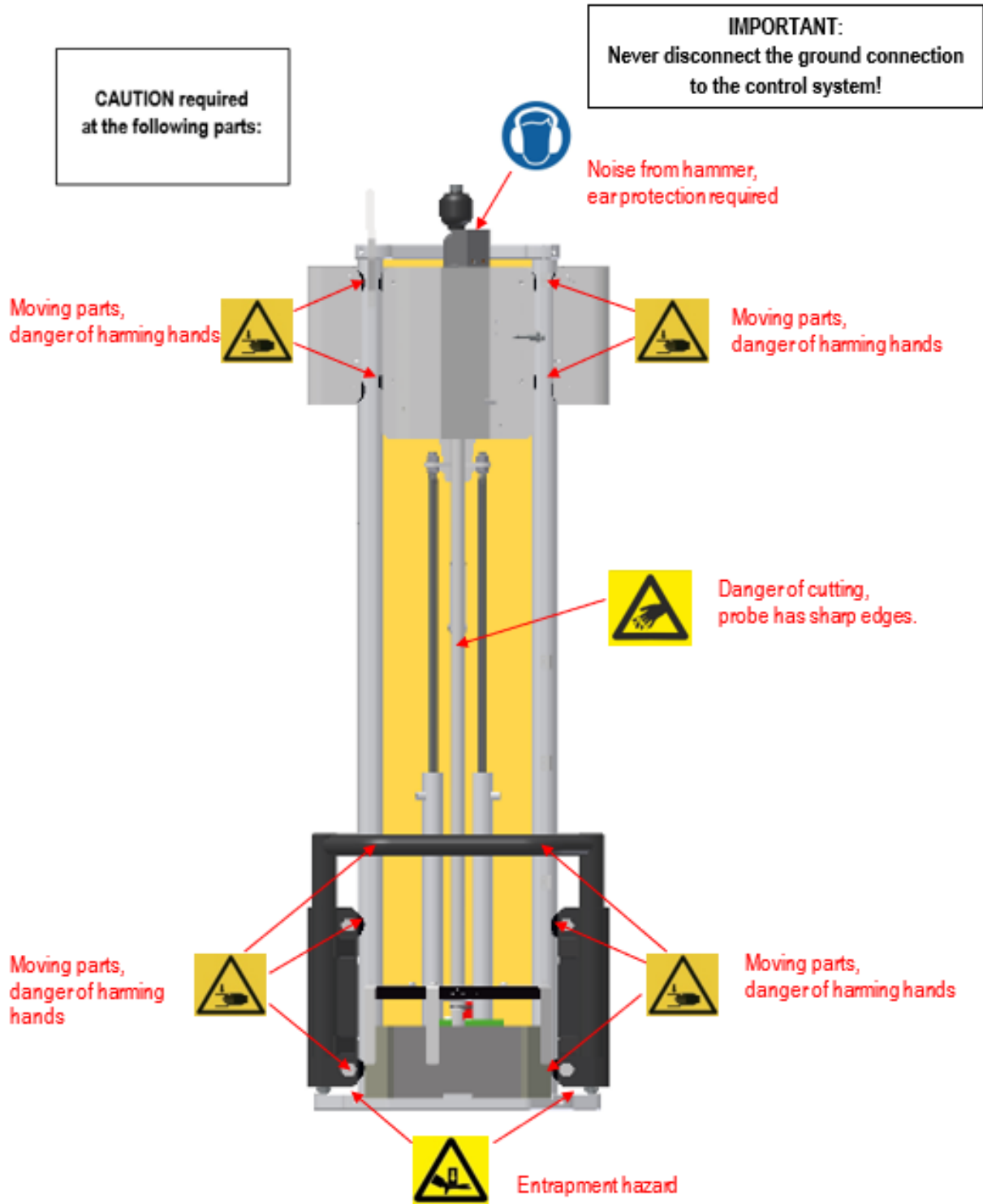

Mounting guidelines

2. A. MOUNTING THE WINTEX ON A REGULAR FRAME



Fitting the mounting frame

There are four brackets enclosed in the Wintex package which you need for mounting the soil sampler onto the frame.

It might be necessary to drill new holes for the brackets or weld the brackets to the chassis of the vehicle. The mounting frame must be 20 cm above the ground. Optional: The Wintex can be delivered with 10 cm longer cylinders which allow the mounting frame to be up to 30 cm above the ground.

The mounting frame under the vehicle:



The mounting frame on the side of the vehicle:



Mounting the stabilizers

Mount the stabilizers at the front and the back.
Then tighten the bolts on the side of the frame.



Mounting guidelines

The bolts must be tightened to the mounting frame.

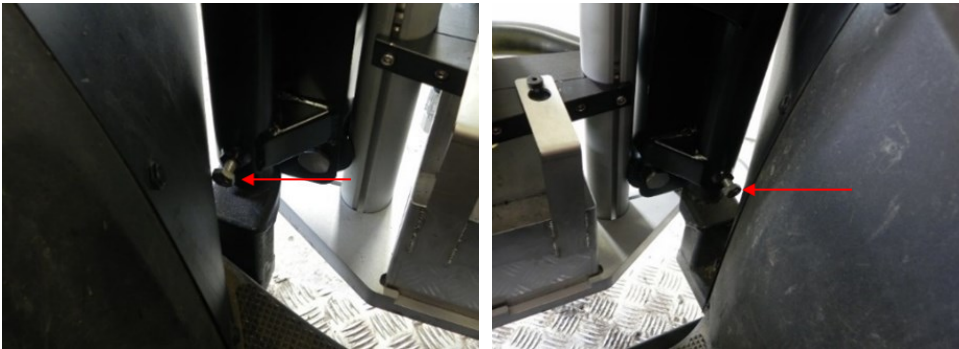

Fitting oil pump and Honda GX200 engine

Oil pump and Honda GX200 engine on a John Deere 855D

The numbers of the hoses and the numbers on the hydraulic block must match and be connected accordingly.



Mounting guidelines

2. B. MOUNTING THE WINTEX ON A REVERSED FRAME



The reversed frame always needs to be customized so that it fits the vehicle in question. Therefore the frame is delivered unpainted.

Here are some examples on how customers mounted the reversed frame onto their vehicles:



Mounting guidelines

2. C. MOUNTING THE WINTEX ON A PICKUP FRAME

The pickup frame includes everything you need for mounting the soil sampler in the bed of a pickup truck, but not for mounting the hydraulic unit. Some vehicles have a bed which is big enough to place the hydraulic unit beside the soil sampler. Other vehicles are narrower or shorter. Therefore, it might be necessary to make a bracket to mount the hydraulic unit on top of the wheel tub or even on the side of the cargo bed.

Make sure that there is enough space in the bed of the pickup so that the soil sampler can be carried in transport position. Then make sure that the soil sampler can be tilted at the rear end of the vehicle and that it can withstand bumper and tow bar.

The frame needs to be bolted down into these six mounting points. It might be necessary to put big washers underneath the frame to reinforce the bed.

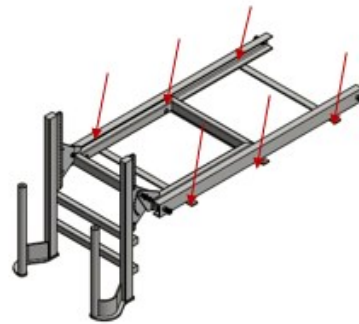

When the soil sampler is mounted, you need to loosen the position lock bolts on the frame and pull the inner frame backwards. When you reach the stop, make sure that the position lock bolts engage in the holes to secure the soil sampler. Then release the position lock bolts of the tilting frame and raise the soil sampler by hand into the working position. Make sure that the lock bolts engage.

The tilting part of the frame is locked with position lock bolts. You can adjust the angle so that you can tilt the soil sampler 90 degrees to the ground.

Depending on the size of the pickup, you need to find a suitable mounting position for the hydraulic unit. There is no harm in offsetting the soil sampler to one side of the bed to make space for the hydraulic unit.



Mounting guidelines

2. D. MOUNTING THE WINTEX ON A TRACTOR



The Wintex soil sampler is delivered with a 12 V socket which must be connected to the 12 V plug of the tractor.

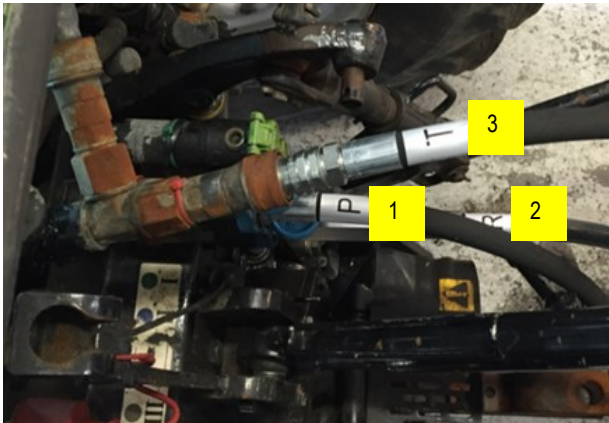

Connecting the hoses:

Hose P (1) must be connected to the hydraulic pressure port of the tractor.

Hose R (2) must be connected to the hydraulic return port of the tractor.

Hose T (3) must be connected directly to the pressureless return part of the tractor.

Using the WINTEX

3. A. DESCRIPTION OF THE CONTROL SYSTEM



- | | |
|---------------------------|---------------------|
| 1: Extra rotation | 8: Program process |
| 2: Up / plus | 9: Split mode |
| 3: Preset depth | 10: Down / minus |
| 4: Escape | 11: Menu / ENTER |
| 5: Reset | 12: Sample mode |
| 6: Probe up / down + STOP | 13: Manual override |
| 7: Foot up / down + STOP | 14: Rotation + STOP |
| | 15: START + HOME |

Any activation of part no. 6, 7 and 14 will stop the soil sampler.

Using the WINTEX

3. B. CONNECTION AND START UP

Connect the control system to 12 V DC as indicated on the cables. The system needs a 10-amp fuse which must be connected to the battery as close as possible.

At the start-up, the display shortly shows the version of the software and then automatically moves on to the start display. The first row shows the depths which are preset from the factory:

Wintex 1000s: 30 cm
 Wintex 2000: 30 and 60 cm
 Wintex 2500: 20, 40 and 60 cm
 Wintex 3000: 30, 60 and 90 cm
 Wintex 3000s: 30, 60 and 100 cm

The second row shows the activated mode of operation. If the soil sampler is resting in "HOME" position, the display will show the mode "Ready".



3. C. SETUP MENU

In the "Setup Menu" you can preset and adjust several settings. Press "**MENU**". The display will now show "Setup Menu".

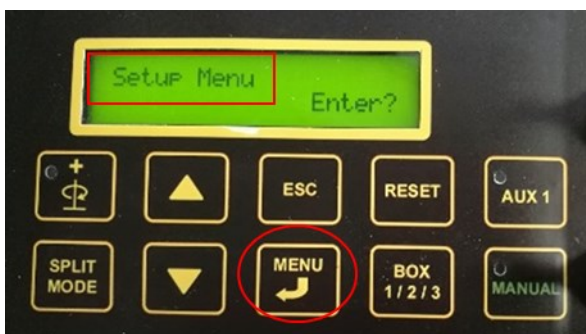

You can **shift** between settings by using the arrow up and arrow down keys.

The settings can be **adjusted** by holding the "**MENU**" key down until the number of the display flashes. Then adjust the figure by using the arrow up or arrow down keys. When you have entered the preferred number, press "**MENU**" (enter) again, and the setting is saved.

Using the WINTEX

3. D. SETTINGS: DEPTH

You can adjust the depth in which the soil samples are taken. Depending on the type of soil, you can adjust the following depths:

Wintex 1000s: depth1

Wintex 2000: depth 1 and depth 2

Wintex 2500: depth 1, depth 2 and depth 3

Wintex 3000: depth 1, depth 2 and depth 3

Wintex 3000s: depth 1, depth 2 and depth 3



3. E. SETTINGS: STICKS PER SAMPLE

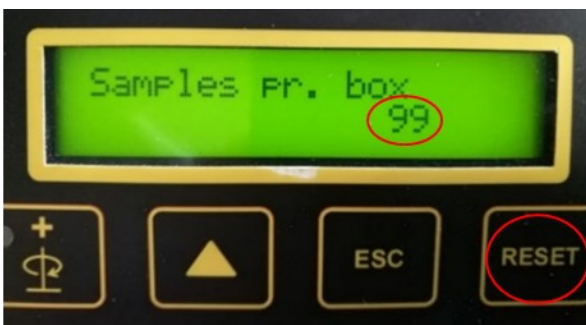

You can preset the number of sticks (arrow up for rising the numbers, arrow down for lowering the numbers) for each sample. When the soil sampler has taken the entered number of sticks, it will not take another sample before you press "RESET". By entering the number 99, you can disable this function, and the soil sampler will sample indefinitely.

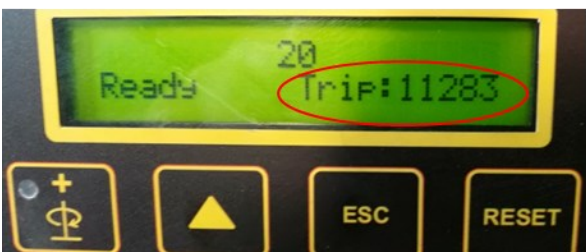

There is a counter at the bottom of the right which counts the number of sticks in each sample. The counter can be reset to 0 by pressing "RESET". You get access to this function from the start screen, and then press the arrow down key.



You can also see the total amount of sticks taken. This value cannot be reset.

Using the WINTEX

3. F. SETTINGS: LAYERS PER SAMPLE, SPLIT MODE, SOIL BOX

Determine the number of layers per sample

Press the “**SPLIT MODE**” key to determine the number of layers. Depending on the type of soil sampler, it is possible to take soil samples from one, two or three layers.

Wintex 1000s:

One number will appear at the top of the display as it only is possible to take a sample from one layer.

Wintex 2000:

Two numbers will appear on the display which means that you will take a samples from two layers. You can also use the Wintex 2000 to take a sample from just one layer. In this case press “**SPLIT MODE**” until just one number appears on the screen. Use the “**SPLIT MODE**” key to shift between these options.

Wintex 2500, 3000, 3000s:

Three numbers will be shown on the screen meaning that you are about to take a sample from three layers at the same time. With the Wintex 2500, 3000 and 3000s you do also have the option to take a sample from one or two layers. As mentioned above, use the “**SPLIT MODE**” key to shift between these options (one number on the screen = sampling in one layer, two numbers visible = sampling in two layers, three number on the screen = sampling in three layers).



Choosing of soil box

With the Wintex 2000, 2500, 3000 and 3000s you have the option to determine a specific soil box into which the soil will be delivered. Shift between the soil boxes by using the “**BOX 1/2/3**” key.



Soil box right
(Wintex 2500, 3000, 3000s)



Soil box left (Wintex 2000)
Soil box middle (Wintex 2500, 3000, 3000s)



Soil box left
(Wintex 2500, 3000, 3000s)

Using the WINTEX

3. G. SOIL SAMPLING

When everything is set, stay clear of the soil sampler, and flip the “**START / HOME**” switch towards “**START**”. The soil sampler will now take a complete sample.

Stop the soil sample

Should you encounter a problem during sampling, you can either activate the emergency stop, or you can flip any of the switches on the control unit to stop the soil sampler. When flipping the “**START / HOME**” switch to “**HOME**”, the soil sampler will return into the start position.



3. H. DOUBLE ROTATION



Press the key with the rotation symbol to perform an extra rotation which can be advantageous in some kinds of soil.

3. I. FOOT PRESSURE



If the soil sampler is not pressed firmly against the ground, you need to adjust the foot pressure by using the **MENU** and arrow keys as mentioned above.

The pressure should be set at a value so that the foot of the soil sampler lifts the suspension of the vehicle just a little bit. If the soil sampler is lifted of the ground during sampling, you need to adjust the pressure of the probe.

Using the WINTEX

3. J. TEST MENU

By entering the **Test Menu** you can see the current

- power supply
- pressure
- depth.

You can also monitor and see the control system's

- keys
- switches
- LEDs
- digital inputs
- analog / current inputs
- outputs
- current outputs
- current software version.



Enter the test menu by pressing the **"MENU"** key. The screen will now show "Set up Menu". Press the arrow down key, and the "Test Menu" will appear.

Press **"MENU"** again, and you will now have access to the above-mentioned content.

You can **shift** between the content by using the arrow up and arrow down keys.

In some cases it seems like you only can see for example one of four (1/4) "pages" on the screen. To view the other "pages", press the **"MENU"** (enter) key.

Using the WINTEX

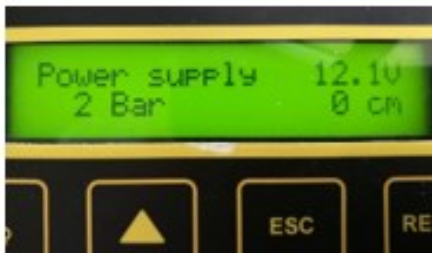

Current power supply, pressure, and depth



Monitor keys



Monitor switches



Monitor LEDs

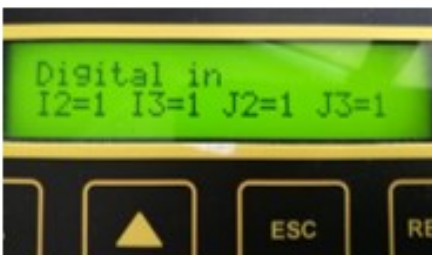

Digital inputs

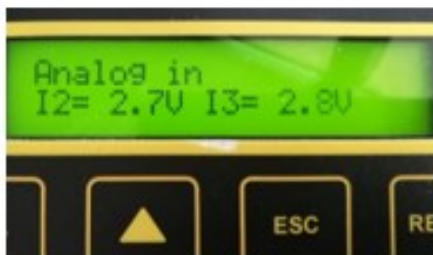

Analog inputs

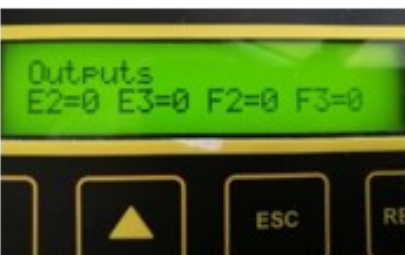

Outputs

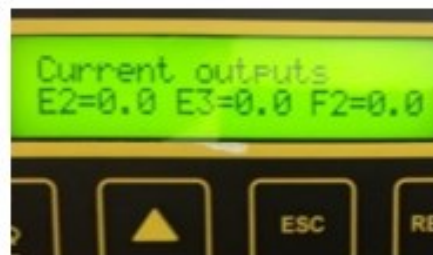

Current outputs

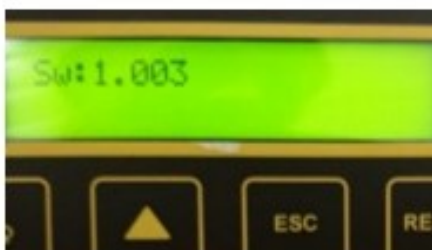

Software version

Using the WINTEX

Overview control system

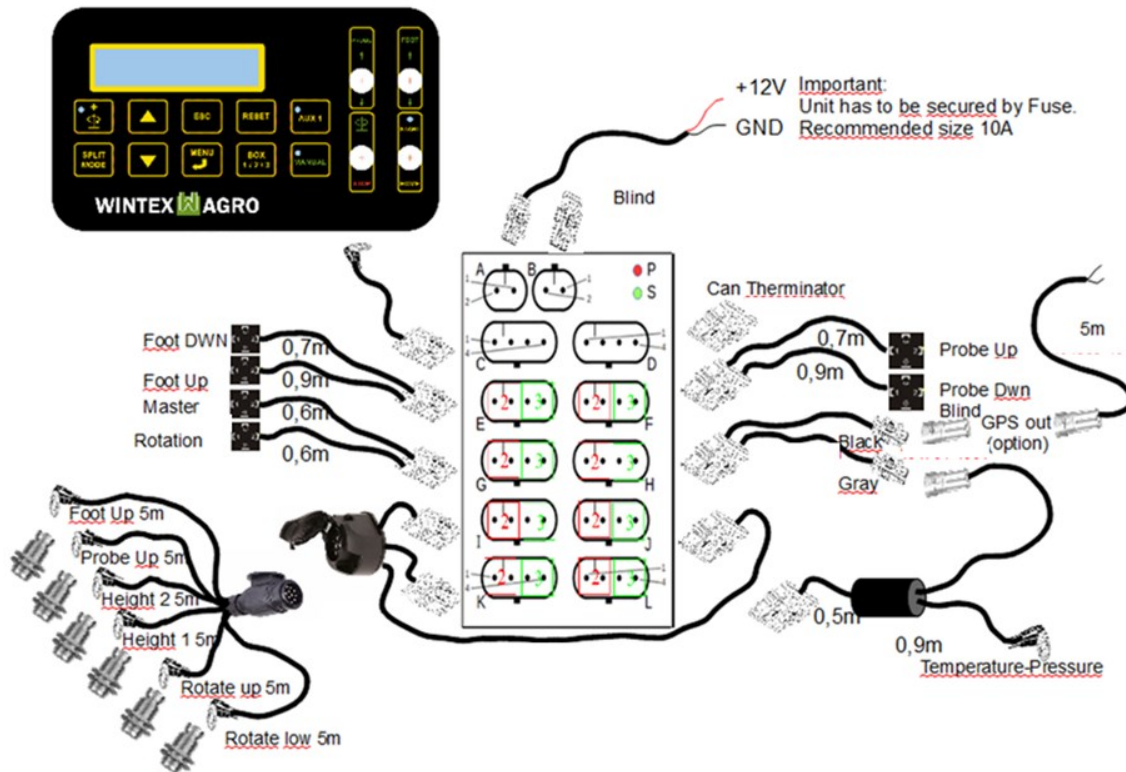

Diagnostic sheet

Plug	Type of signal	Function	Out / in	Trouble shooting	
A	12 V	Power supply	12 V		
B	-	-	-		
C	Can	Terminal	-		
D	-	-	-		
E2	Out	Foot up valve	12 V; 1,7 A		
E3	Out	Foot down valve	12 V; 1,7 A		
F2	Out	Probe up valve	12 V; 1,7 A		
F3	Out	Probe down valve	12 V; 1,7 A		
G2	Out	Rotation valve	12 V; 1,7 A		
G3	Out	Main valve	12 V; 1,4 A		
H2	Impulse	GPS	12 V; 0,1 A		
H3	Power	Transducer power	12 V; 0,01 A		
I2	In	Probe up sensor	2,7 V / 10 V	2,7 V indicates that the sensor is active. 10 V indicates that the sensor is not active.	12 V indicates that the power supply for the sensor/cable is broken. 0 V indicates that the sensor/cable is shortened.
I3	In	Foot up sensor	2,7 V / 10 V		
J2	In	Upper rotation sensor	2,7 V / 10 V		
J3	In	Lower rotation sensor	2,7 V / 10 V		
K2	In	Height sensor 1 (lower sensor))	2,7 V / 10 V		
K3	In	Height sensor 2 (upper sensor)	2,7 V / 10 V		
L2	Analog	Oil pressure (foot)	0 – 10 V		
L3	Analog	Oil temperature	0 – 10 V		

Using the WINTEX

3. K. SENSOR ADJUSTMENT

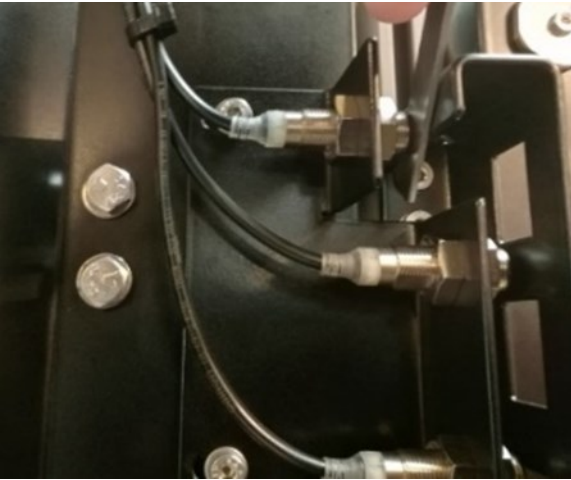

Make sure that the gap between each sensor and the sensor rail is 2-3 mm.

The gap between the sensors for rotation and the rotary sensor plate as well as the gap between the foot sensor and the detecting bolt must be 1 mm.



If a sensor is adjusted correctly and is in front of the sensor rail, the sensor will light up green. This means that the sensor works.



If the sensor light is orange, the sensor is still working, but either the gap is incorrect, or the sensor is on the edge of one of the sensor rail holes.

If the sensor is adjusted to far away from the rail, the light will also turn orange. The sensor will still give the correct signal, but there is a risk of wrong readings, thereby giving an incorrect height.

When the soil sampler is moving downwards, the sensors will flash orange and green. This is perfectly normal as the sensors pass the holes in the rail. If the sensor stays orange over a longer distance (10-15 cm), they need to be adjusted, or the rail may be bent.

Maintenance

4. A. REPLACEMENT OF O-RING, SCRAPER AND PROBE

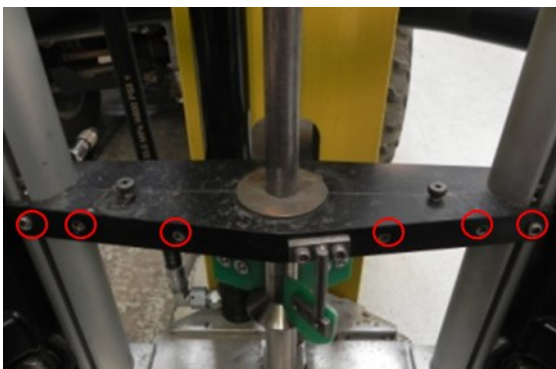
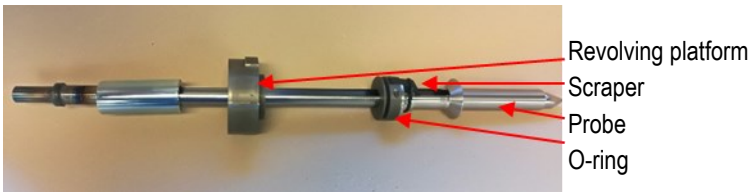

Replacement of probe

Remove the soil box and unscrew the six bolts with a 5 mm hex key. Both halves of the retainer can now be removed.

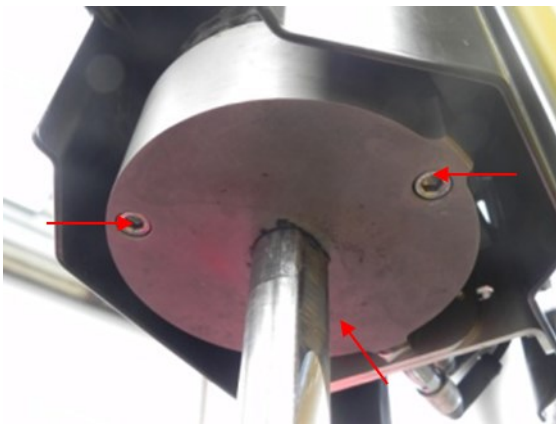

Unscrew the three bolts. The revolving platform can now be pulled down along the probe.

Caution: The probe as sharp edges!



Remove the retainer with the special key which is delivered together with the WINTEX. It is now possible to remove the probe.

Maintenance



Replacement of the probe

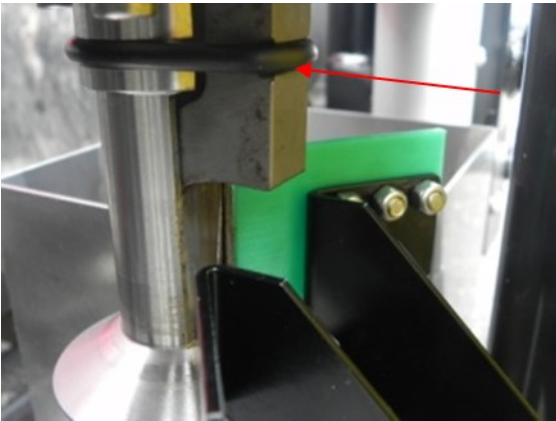

Replacement of o-ring

When the probe is removed, it is possible to replace the o-ring.

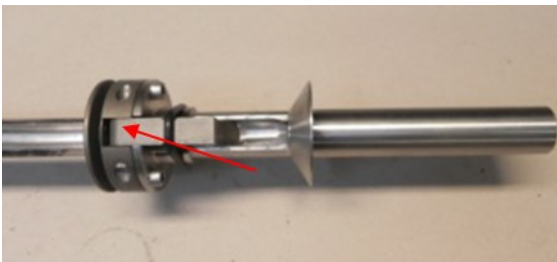

Replacement of scraper

At first force the spring roll pin out. Then replace the scraper and replace the old spring roll pin with a new one.

Maintenance

4. B. ADJUSTMENT OF CHAIN FOR ROTATION

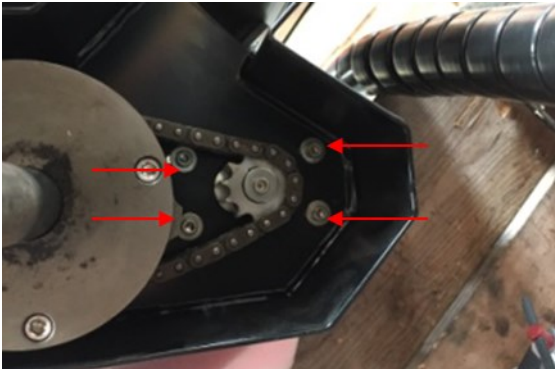

Loosen the four screws with a 4 mm hex key.

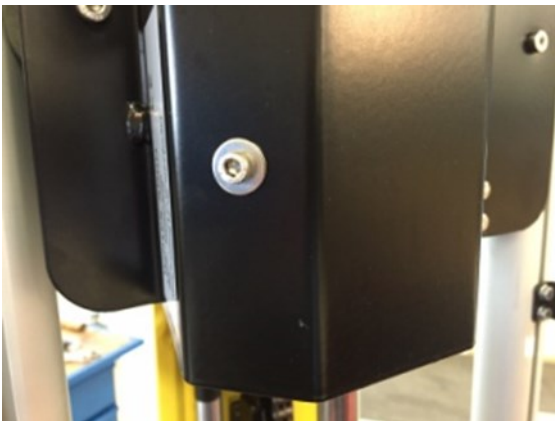

Then adjust the chain for rotation by turning the inset bolt (clockwise to tighten the chain, counterclockwise to loosen the chain). When the chain is adjusted correctly, the four screws must be tightened again. Use a 4 mm hex key.

4. B. ADJUSTMENT OF CHAIN FOR PROBE UP OR DOWN

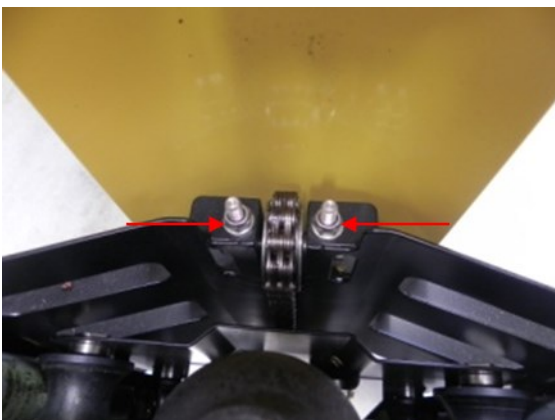

Move the probe approximately 20 cm down. Activate the emergency stop to stop the soil sampler, and turn off the engine. The chain can now be adjusted by tightening the bolts.

Maintenance

4. D. HYDRAULICS

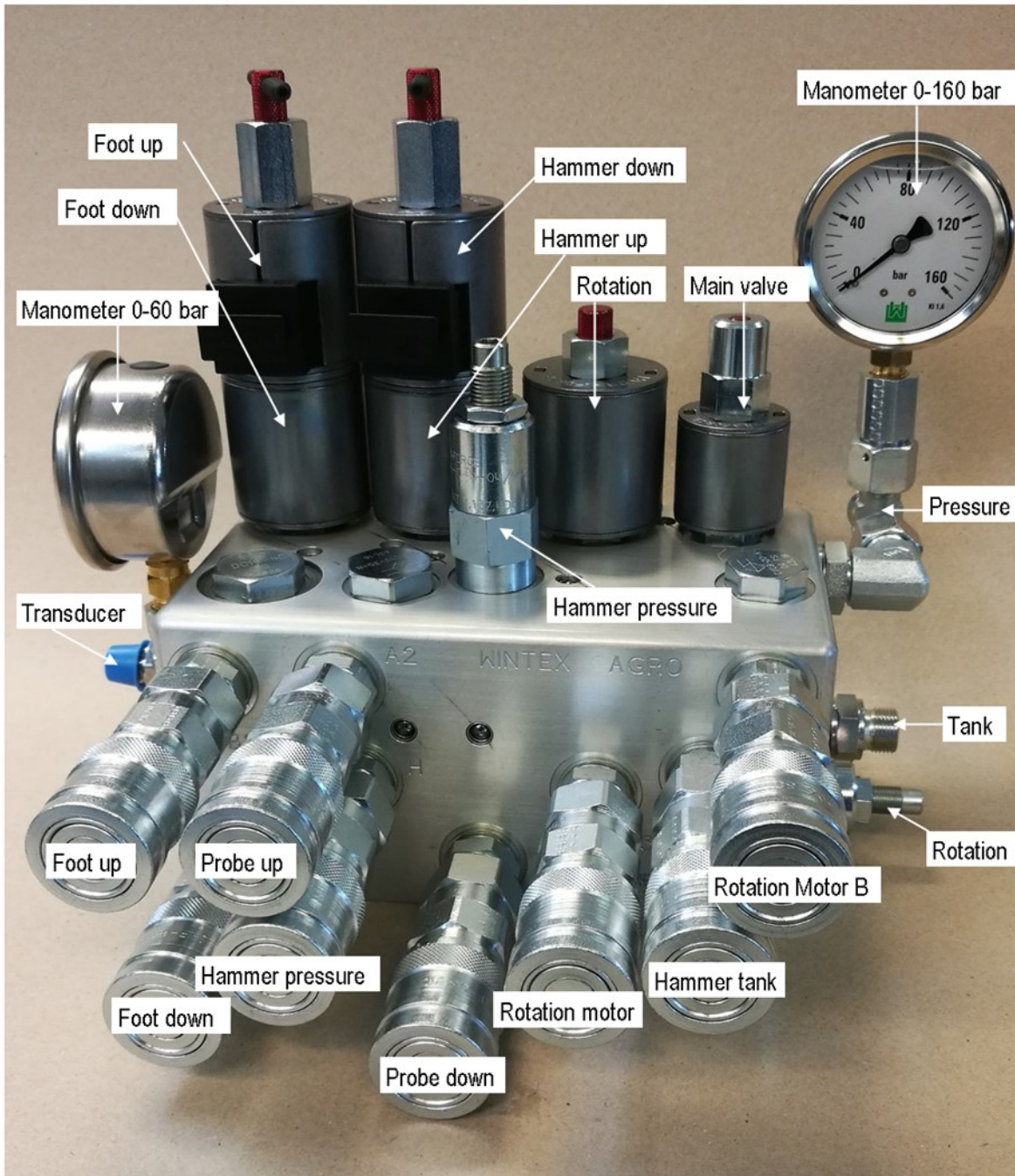

Maintenance

4. E. MANUAL ACTIVATION OF THE HYDRAULIC VALVES

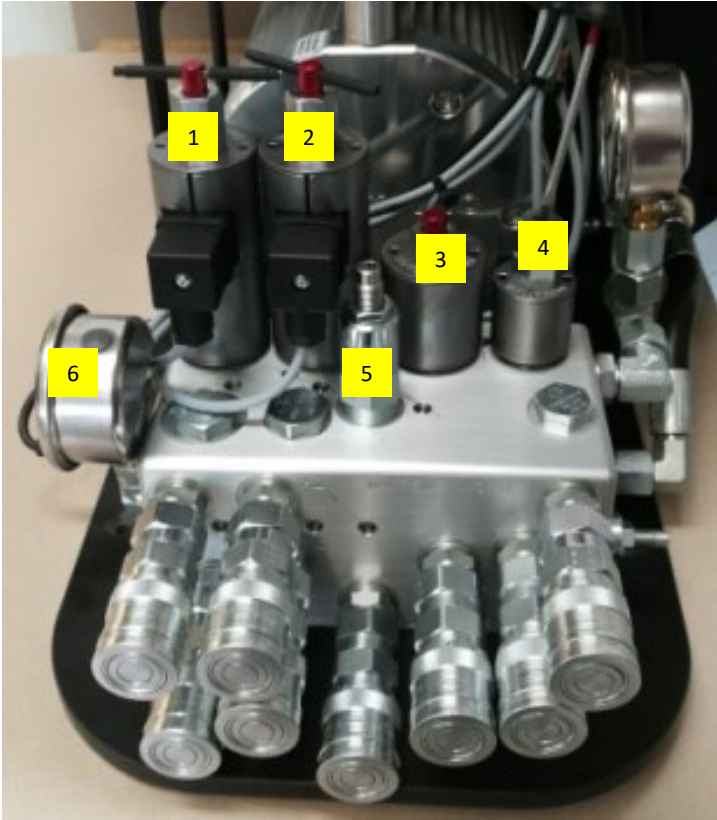

Soil sampler up/down (1):

The soil sampler goes down when pressing the valve. The soil sampler goes up when pulling the valve.

Probe up/down (2):

The probe goes down when pulling the valve. The probe goes up when pushing the valve.

Rotation (3):

Screw counterclockwise to activate the rotation process. Then press the main valve (4).

Important: Reset the button into start position after use.

Adjustment of probe pressure (5)

Reading the probe pressure during sampling (6)

Do always activate the function of a valve first before activating the main valve (4) by pressing it down.

Maintenance

4. F. ADJUSTMENT OF THE HYDRAULICS



Adjusting the main pressure

Start the motor with max. r.p.m. Press the main valve. The manometer must show 80-120 bar. On soil samplers with a display the pressure is shown electronically.



The excess-pressure valve which is located under the red cap is for adjusting the main pressure. The main pressure is preset on 120 bar. It must only be adjusted after signing a written agreement with Wintex Agro.



Adjusting the pressure of the probe

Loosen the lock nut. Adjust the pressure with a 6 mm hex key. Pressure will rise when turning to the right and lower the pressure by turning to the left. If the hammer will not move down, or if the soil sampler is lifted of the ground when sampling, the pressure must be lowered.

When taking a 0-15 cm sample it can be advantageous to lower the probe pressure which will result in a better sample.



Depending on the vehicle's weight and the kind of soil, the pressure must be between 10 and 30 bar. Read the pressure on this manometer which only is for reading the pressure of the probe when it is moving downwards.

Maintenance

4. G. DISMOUNTING THE ACCUMULATOR



Use a 4 mm hex key. Make sure that it is in good condition and that the bolt is clean.



Loosen the screws carefully with the 4 mm hex key.
Note: There are two screws in each hole.



Use a 3 mm hex key. Make sure that it is in good condition and that the bolt is clean.



Maintenance

4. H. CONTROL OF THE ACCUMULATOR



Put a long rod down into the hole of the accumulator to check if the accumulator is pressurized. If the diaphragm can be pushed a lot, the accumulator must be charged with nitrogen or the diaphragm is defective. In case of a defective diaphragm, the accumulator must be replaced.



Loosen the charging screw with a 6 mm hex key. If the accumulator is in order, you can hear a whistling sound from the nitrogen. In this case merely recharge the accumulator. If there is no whistling sound, the diaphragm is probably damaged and must be replaced.

Maintenance

4. I. CHANGING OIL AND OIL FILTER



Close the filling hole with a solid plug.

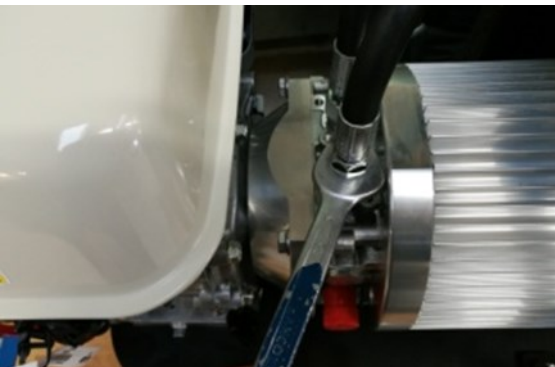

Remove both hoses.



Unbolt the engine and the tank.



Remember the bolt under the tank.

Maintenance



Slide the engine and the tank out under the cooler bracket and unbolt the engine.

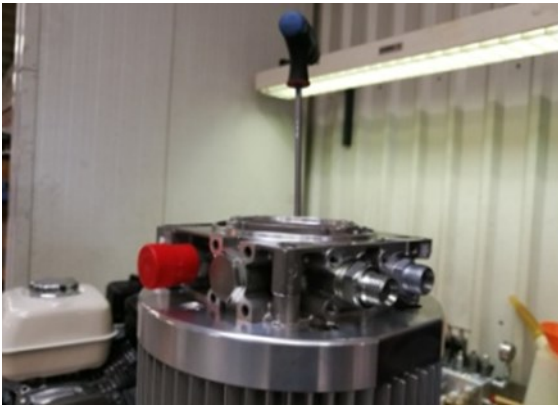

Move the tank into an upright position and unscrew the pump.



Replace the filter with a new one. Clean the tank thoroughly.



Then remount pump, tank and engine.

Maintenance

4. J. MAINTENANCE SCHEDULE

Daily:

- After three hours in use tighten all screws and bolts.
- Check the chain for rotation. Lubricate if necessary.
- Check the upper end of the probe. Lubricate if necessary.
- Check the grease fitting for rotation. Lubricate if necessary.
- Check all screws and bolts.
- Clean the probe and the scraper.
- Clean the soil box.
- Clean the scraper blades.
- Common cleaning of the soil sampler.
- Check the level of the hydraulic oil and refill with oil if necessary.
- Check the hydraulics for leaks.
- Clean the oil tank.
- Clean the oil cooler.
- Check the hoses for damage.

Check weekly and exchange/adjust if necessary:

- | | |
|----------|---|
| 50101038 | Guiding rolls |
| * | Guiding pipe: *please check the spare parts catalogues for correct numbers |
| * | Rotary sensor plate: *please check the spare parts catalogues for correct numbers |
| 50101044 | Slide bearing |
| 50101045 | Gearwheel for rotation, 30 teeth |
| 50101046 | Gearwheel for rotation, 12 teeth |

Check daily and exchange if necessary:

- | | |
|----------|---|
| 50101004 | O-ring for scraper |
| 50101003 | Scraper |
| 50101014 | Scraper blade |
| 50101039 | Spring roll pin for scraper |
| * | Probe: *please check the spare parts catalogues for correct numbers |

Exchange after 500 hours in use and at least once a year:

- | | |
|----------|--------------------------------------|
| 50101198 | Hydraulic oil filter |
| 50101037 | Hydraulic oil |
| 50101229 | Oil level rod with filler cap, large |

Honda GX200 motor:

See instruction manual

Maintenance

PART	INTERVAL	TYPE	QTY.	ADJUST	CHECK DAILY	CHANGE
WINTEX SOIL SAMPLER						
Filler cap	500 hrs / once a year	Wintex				X
Hydraulic oil	500 hrs / once a year	XV 46	7,5 / 4,5		X	X
HONDA ENGINE						
Valves	300 hrs / once a year			X		
Air filter	100 hrs / once a year					X
Spark plug	100 hrs / every six month	BPR6ES	1			X
Engine oil	100 hrs / every six month	5w-30 / 10w-30 API-SJ or better	0,6		X	X

4. K. REPLACEMENT OF SENSORS

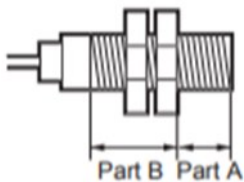

If a sensor needs to be replaced, do not tighten it with excessive force and follow these instructions:

- If the nut is within part A which is 16 mm long, it must be tightened with 6 Nm.
- If the nut is within part B, it must be tightened with 15 Nm.

Problem solving

5. A. FAULT LOCATION SOIL SAMPLER

PROBLEM	CAUSE	POSSIBLE SOLUTIONS
The WINTEX does not start soil sampling.	<ol style="list-style-type: none"> 1) The fuse is blown. 2) The emergency stop is activated. 3) The top sensor is broken. 4) A switch is broken. 5) There is a gap between the top sensor and the upper sensor plate. 6) The hydraulic oil is overheated. 	<ol style="list-style-type: none"> 1) Replace the fuse with a new 7.5-amp fuse. 2) Deactivate the emergency stop. 3) Replace the sensor with a new one. 4) Replace the switch with a new one. 5) Adjust the upper sensor plate. The gap should be 2-3 mm. 6) Wait until the oil has cooled down.
The soil sampler does not reach the ground before the probe starts to move downwards.	<ol style="list-style-type: none"> 1) There is too much oil supply, or the oil viscosity is too high. The oil might be too cold. 	<ol style="list-style-type: none"> 1) Change the oil. Heat the oil up by running the foot manually up and down. Alternatively raise the foot pressure. Contact the dealer for more settings.
The hammer has no or too little power.	<ol style="list-style-type: none"> 1) The probe is mechanically blocked. 2) The pressure accumulator is broken. 3) The hydraulic oil pump is broken. 4) The hydraulic oil filter is blocked. 5) The probe is defective. 	<ol style="list-style-type: none"> 1) Remove potential nicks. Lubricate the probe. 2) Replace the accumulator with a new one. 3) Replace the hydraulic oil pump with a new one. 4) Replace the hydraulic oil filter. 5) Replace the probe. The probe must be able to move freely for 15-20 mm.
The probe does not rotate properly.	<ol style="list-style-type: none"> 1) The push button on the rotation valve is activated. 2) The sensors for rotation are not adjusted correctly. 	<ol style="list-style-type: none"> 1) Deactivate the push button by pressing and turning it clockwise. Then release the button. 2) Adjust the sensor. The gap should be 1-2 mm.
The probe gets stuck when moving upwards.	<ol style="list-style-type: none"> 1) There are nicks/notches on the probe. 2) The revolving platform is not lubricated sufficiently. 	<ol style="list-style-type: none"> 1) Remove/repair the nicks. If there are notches, mount a new probe. 2) Lubricate the revolving platform.
The oil gets overheated.	<ol style="list-style-type: none"> 1) The fuse for the electric fan is blown. 2) The thermostatic switch for the fan is broken. 3) The cooling fins are blocked. 	<ol style="list-style-type: none"> 1) Exchange the 15-amp fuse in the electricity box. 2) Replace the thermostatic switch for the fan with a new one. 3) Clean the cooler fins.
The soil sample is not divided correctly.	<ol style="list-style-type: none"> 1) The gap between the sensor and the rotary sensor plate is too wide. 2) The rotation sensor is broken. 3) The gap between the rotation sensors is not the same. 	<ol style="list-style-type: none"> 1) Adjust the sensor plate in the middle. The gap should be 1 mm. 2) Replace the sensor with a new one. 3) Adjust the sensor.

Problem solving

5. B. FAULT LOCATION HAMMER

Before locating faults, check that the oil flow from the power source is correct and that the pressure relief valve is set correctly.

PROBLEM	CAUSE	POSSIBLE SOLUTIONS
The hammer does not start. There is pressure in hose P.	1) The oil supply goes to connection T instead of connection P. 2) The striking piston is stuck in the cylinder.	1) Switch hose P and hose T. 2) Polish or replace the components.
The hammer works irregularly.	1) There are impurities in the hydraulic oil. 2) The oil level in the power source is too low.	1) Replace the oil and the oil filter. 2) Add hydraulic oil.
The hammer performs badly.	1) There is an internal leak. 2) The oil flow from the power source towards the hammer is incorrect. 3) The accumulator pressure is too low. 4) The return pressure is too high.	1) Dismount the valve housing, and replace the o-rings. 2) Check the oil flow. 3) Charge the accumulator with nitrogen or replace it. 4) Check the power source, the hoses and the filter.